

CREDITS:
 DESIGN - PEGGY O, TODD G. TWD & JONATHAN
 DRAWINGS - JONATHAN
 BUILDER / REMODELER - GULF SHORE HOMES NAPLES FL
 INTERIOR DESIGN - PEGGY O
 PRODUCT / SUPPLIER - WOODMODE FROM TRADEWIND DESIGNS

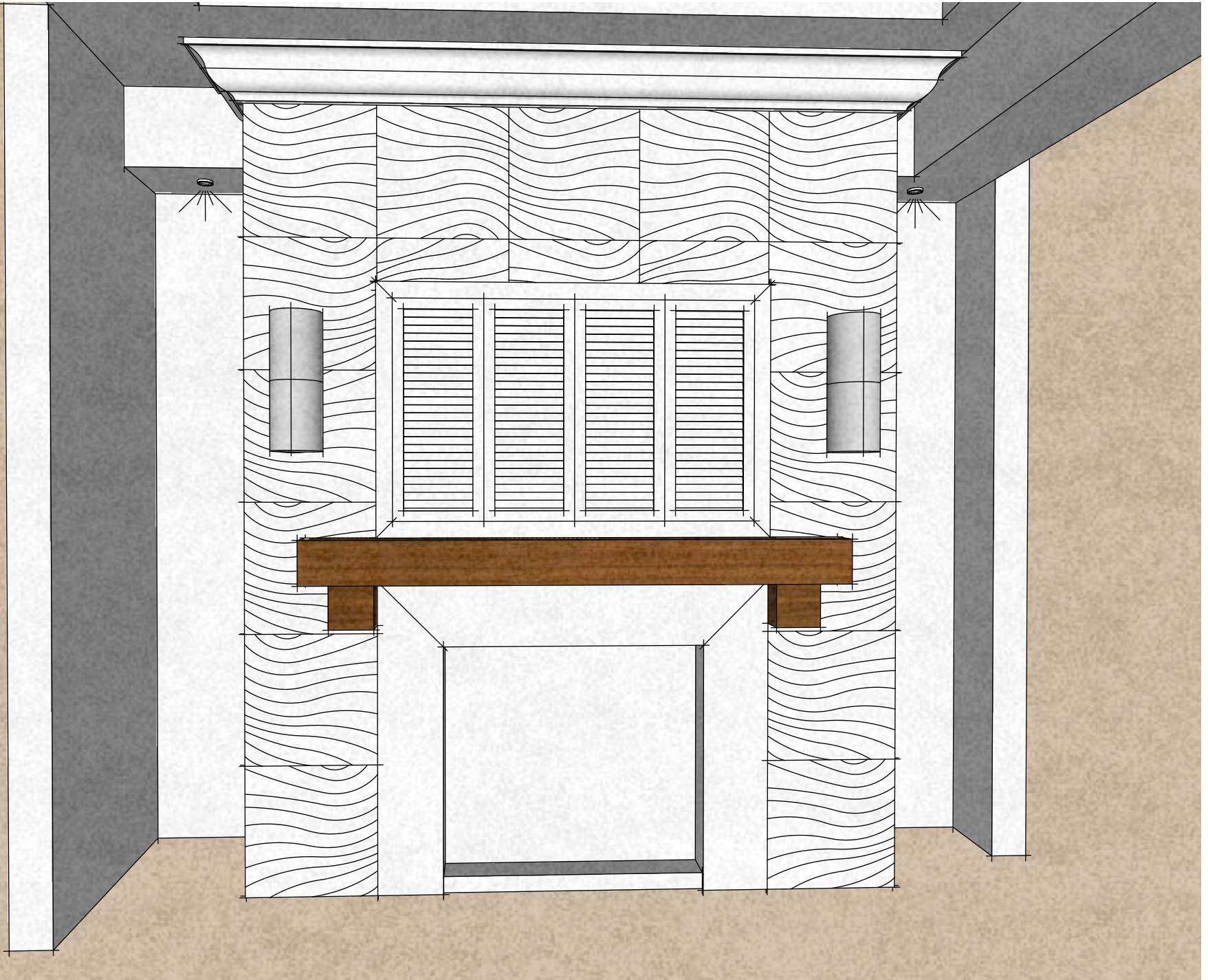

DESIGNS BY JONATHAN
 DRAWINGS ON DEMAND

PRIVATE RESIDENCE
 OUTDOOR LIVING

NOTE: THIS DRAWING IS FOR DESIGN PURPOSES ONLY. VERIFY ALL DEVICES IN FIELD BEFORE INSTALLATION. THIS DRAWING IS NOT NECESSARILY TO SCALE. THE DESIGN, CONCEPTS, SPECIFICATIONS AND DOCUMENTS HEREIN ARE THE PROPERTY OF DESIGNS BY JONATHAN AND ARE FOR GRAPHICAL REPRESENTATION ONLY. VARIATIONS IN WOOD, COLOR, SHAPE, STYLE, AND APPLIANCES WILL VARY. NO PART THEREOF SHALL BE COPIED OR OTHERWISE DISCLOSED TO, OR USED BY OTHERS WITHOUT THE WRITTEN CONSENT OF DESIGNS BY JONATHAN UNTIL SUCH TIME AS CONTRACT BUSINESS DOCUMENTS HAVE BEEN COMPLETED BETWEEN DESIGNS BY JONATHAN AND CUSTOMER.

1	08/11/2014	REVS	SIGN
2	08/28/2014	REVS	
3	11/12/2014	CURRENT	

SKETCH

FLOOR PLAN

scale: 1/2"

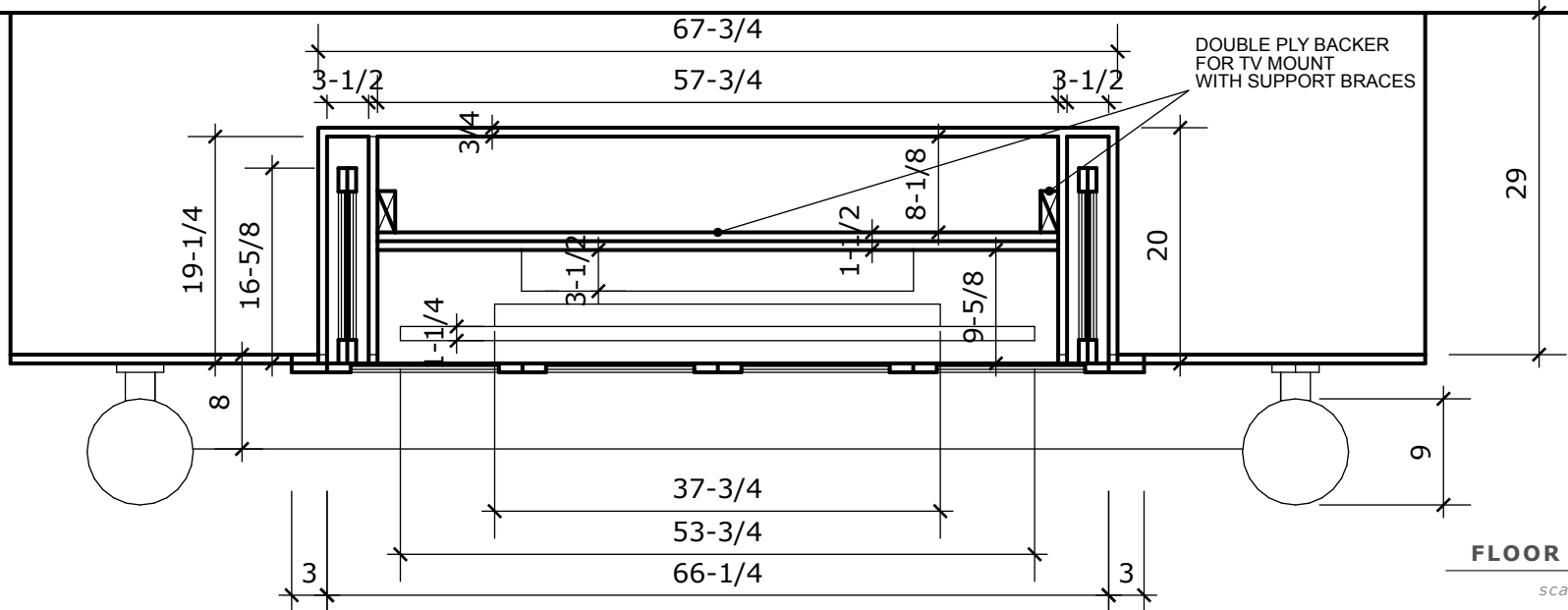
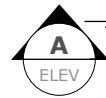
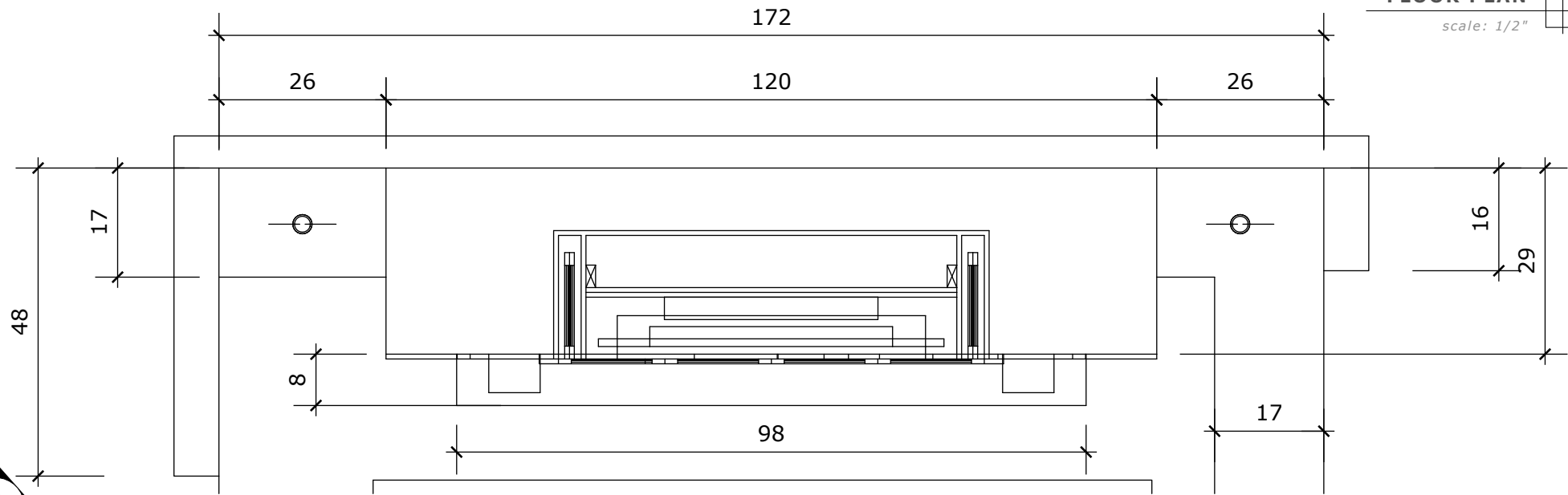

FLOOR PLAN

scale: 3/4"

DESIGNS BY JONATHAN
DRAWINGS ON DEMAND

PRIVATE RESIDENCE
OUTDOOR LIVING

NOTE: THIS DRAWING IS FOR DESIGN PURPOSES ONLY. VERIFY ALL DEVICES IN FIELD BEFORE INSTALLATION. THIS DRAWING IS NOT NECESSARILY TO SCALE. THE DESIGN, CONCEPTS, SPECIFICATIONS AND DOCUMENTS HEREIN ARE THE PROPERTY OF DESIGNS BY JONATHAN AND ARE FOR GRAPHICAL REPRESENTATION ONLY. VARIATIONS IN WOOD, COLOR, SHAPE, STYLE, AND APPLIANCES WILL VARY. NO PART THEREOF SHALL BE COPIED OR OTHERWISE DISCLOSED TO, OR USED BY OTHERS WITHOUT THE WRITTEN CONSENT OF DESIGNS BY JONATHAN UNTIL SUCH TIME AS CONTRACT BUSINESS DOCUMENTS HAVE BEEN COMPLETED BETWEEN DESIGNS BY JONATHAN AND CUSTOMER.

REV	DATE	DESCRIPTION	SIGN
1	08/11/2014	REVS	
2	08/28/2014	REVS	
3	11/12/2014	CURRENT	

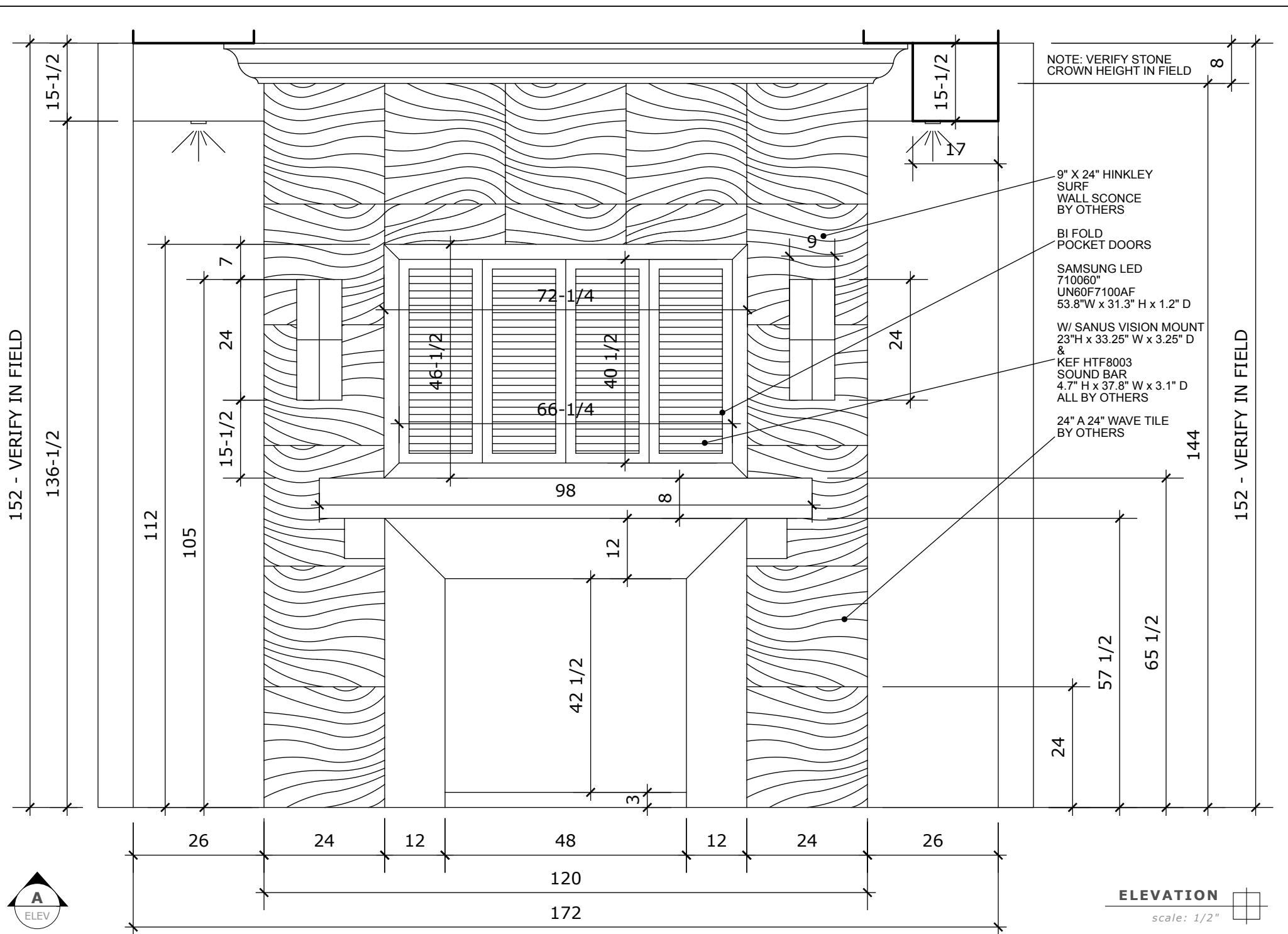

NOTE: VERIFY STONE CROWN HEIGHT IN FIELD

- 9" X 24" HINKLEY SURF WALL SCONCE BY OTHERS
- BI FOLD POCKET DOORS
- SAMSUNG LED 710060 UN60F7100AF 53.8"W x 31.3" H x 1.2" D
- W/ SANUS VISION MOUNT 23"H x 33.25" W x 3.25" D & KEF HTF8003 SOUND BAR 4.7" H x 37.8" W x 3.1" D ALL BY OTHERS
- 24" A 24" WAVE TILE BY OTHERS

152 - VERIFY IN FIELD

152 - VERIFY IN FIELD



ELEVATION
scale: 1/2"

DESIGNS BY JONATHAN DRAWINGS ON DEMAND

PRIVATE RESIDENCE OUTDOOR LIVING

NOTE: THIS DRAWING IS FOR DESIGN PURPOSES ONLY. VERIFY ALL DEVICES IN FIELD BEFORE INSTALLATION. THIS DRAWING IS NOT NECESSARILY TO SCALE. THE DESIGN, CONCEPTS, SPECIFICATIONS AND DOCUMENTS HEREIN ARE THE PROPERTY OF DESIGNS BY JONATHAN AND ARE FOR GRAPHICAL REPRESENTATION ONLY. VARIATIONS IN WOOD, COLOR, SHAPE, STYLE, AND APPLIANCES WILL VARY. NO PART THEREOF SHALL BE COPIED OR OTHERWISE DISCLOSED TO, OR USED BY OTHERS WITHOUT THE WRITTEN CONSENT OF DESIGNS BY JONATHAN UNTIL SUCH TIME AS CONTRACT BUSINESS DOCUMENTS HAVE BEEN COMPLETED BETWEEN DESIGNS BY JONATHAN AND CUSTOMER.

1	08/11/2014	REVS	SIGN
2	08/28/2014	REVS	
3	11/12/2014	CURRENT	

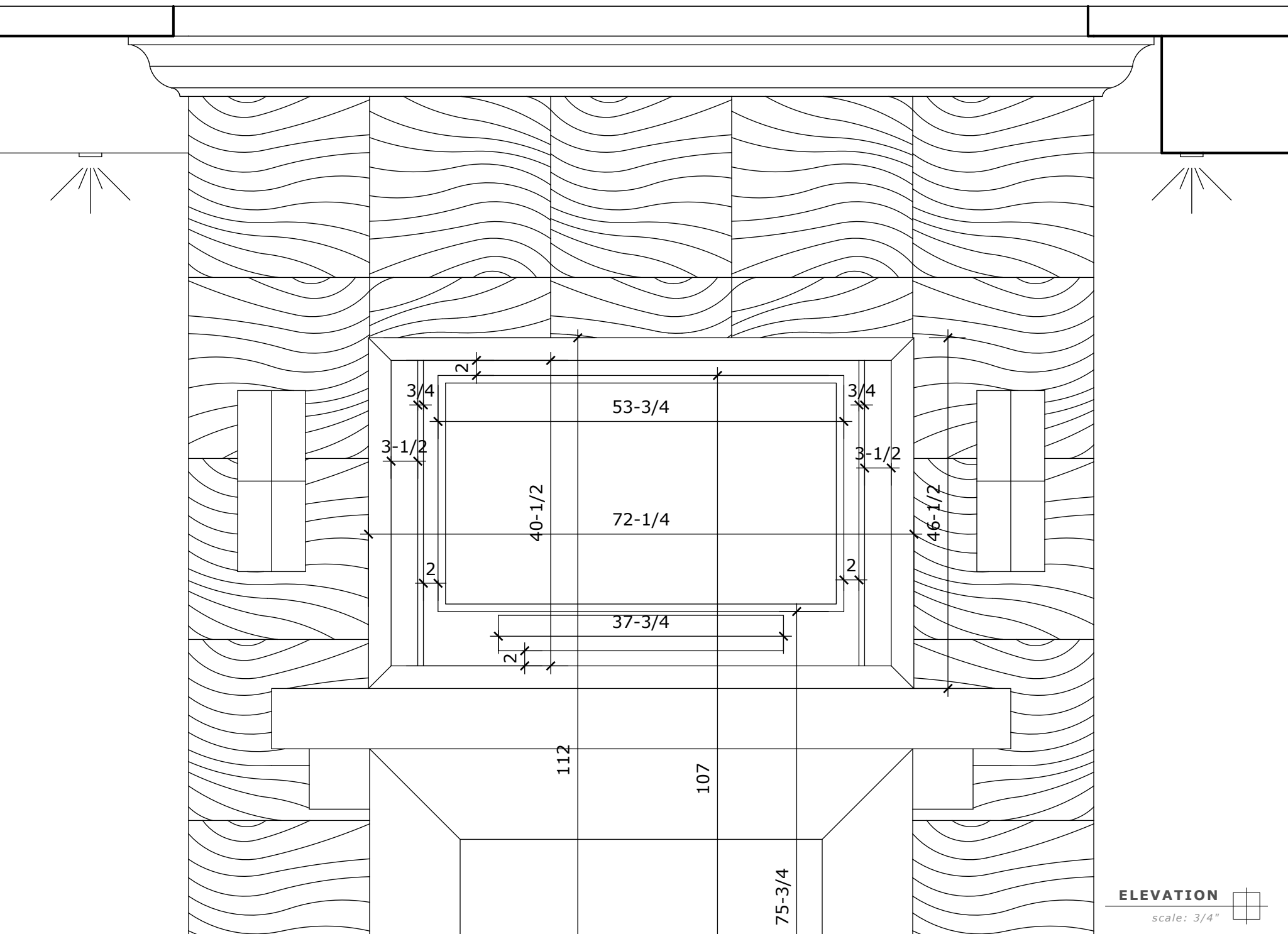

DESIGNS BY JONATHAN
DRAWINGS ON DEMAND

PRIVATE RESIDENCE
OUTDOOR LIVING

NOTE: THIS DRAWING IS FOR DESIGN PURPOSES ONLY. VERIFY ALL DEVICES IN FIELD BEFORE INSTALLATION.
THIS DRAWING IS NOT NECESSARILY TO SCALE. THE DESIGN, CONCEPTS, SPECIFICATIONS AND DOCUMENTS HEREIN ARE THE
PROPERTY OF DESIGNS BY JONATHAN AND ARE FOR GRAPHICAL REPRESENTATION ONLY. VARIATIONS IN WOOD, COLOR,
SHAPE, STYLE, AND APPLIANCES WILL VARY. NO PART THEREOF SHALL BE COPIED OR OTHERWISE DISCLOSED TO, OR USED BY
OTHERS WITHOUT THE WRITTEN CONSENT OF DESIGNS BY JONATHAN UNTIL SUCH TIME AS CONTRACT BUSINESS DOCUMENTS
HAVE BEEN COMPLETED BETWEEN DESIGNS BY JONATHAN AND CUSTOMER.

1	08/11/2014	REVS	SIGN
2	08/28/2014	REVS	-
3	11/12/2014	CURRENT	

ELEVATION

scale: 3/4"



NOTE: VERIFY STONE CROWN HEIGHT IN FIELD

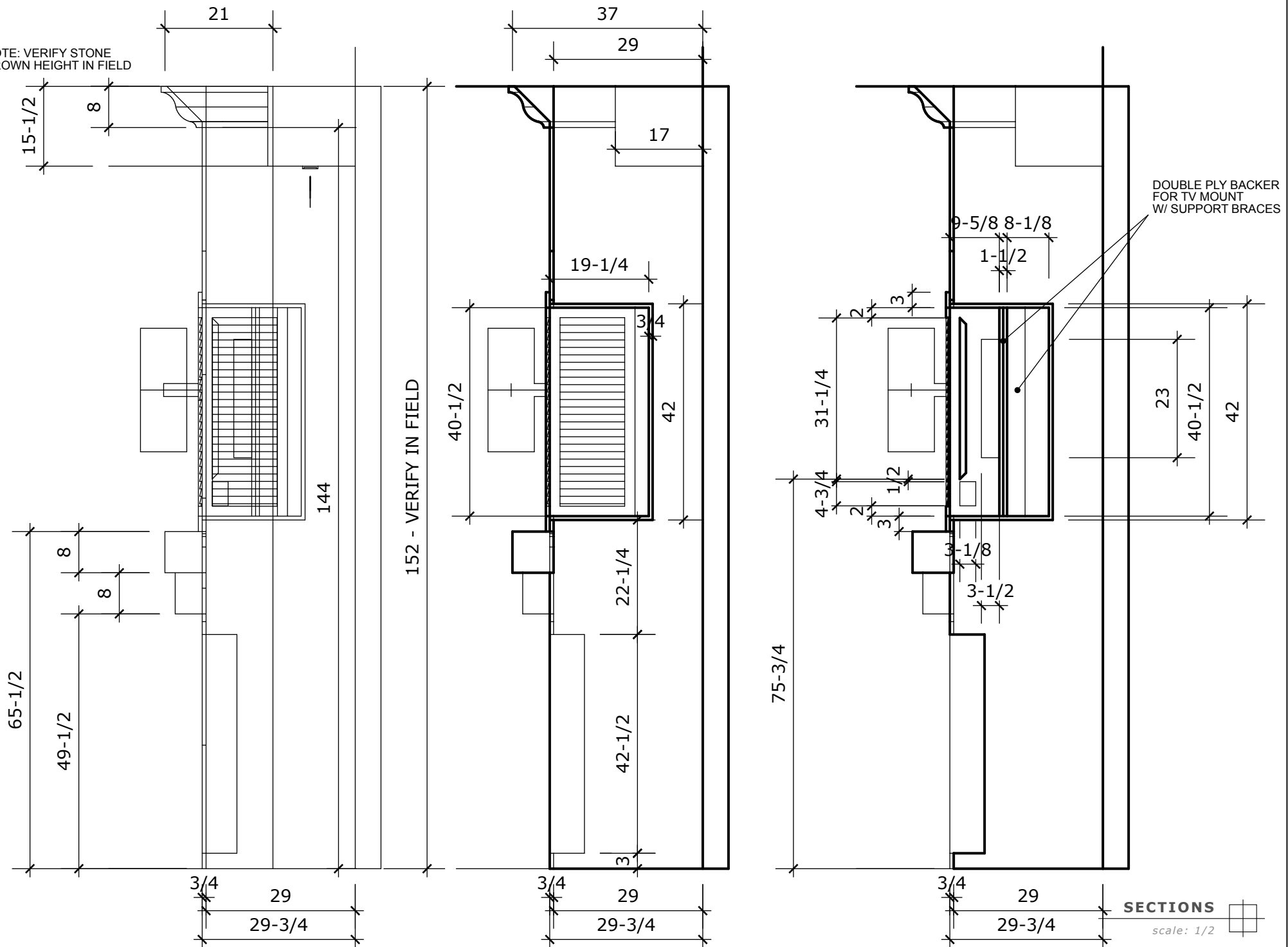

1	08/11/2014	REVS	SIGN
2	08/28/2014	REVS	
3	11/12/2014	CURRENT	